

TOP VIEW

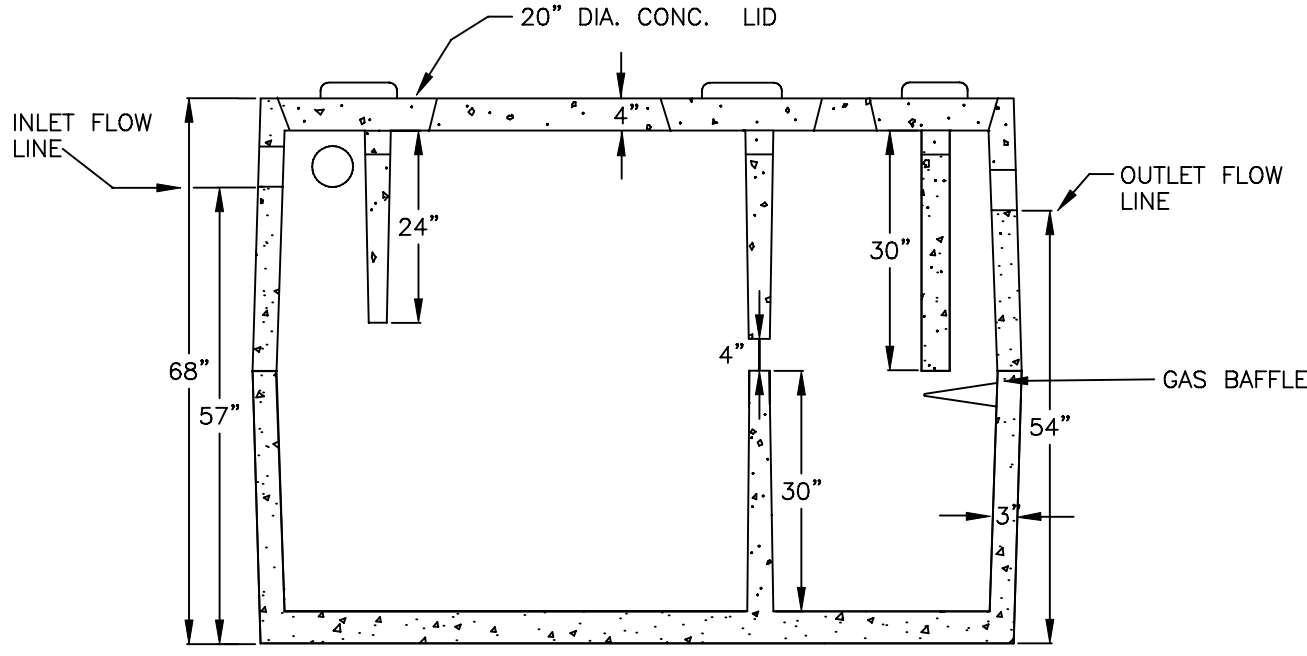

CUT AWAY SIDE VIEW

DARNALL CONCRETE PRODUCTS COMPANY
1000 GALLON SEPTIC TANK DETAIL
6/26/2012