

TOP VIEW

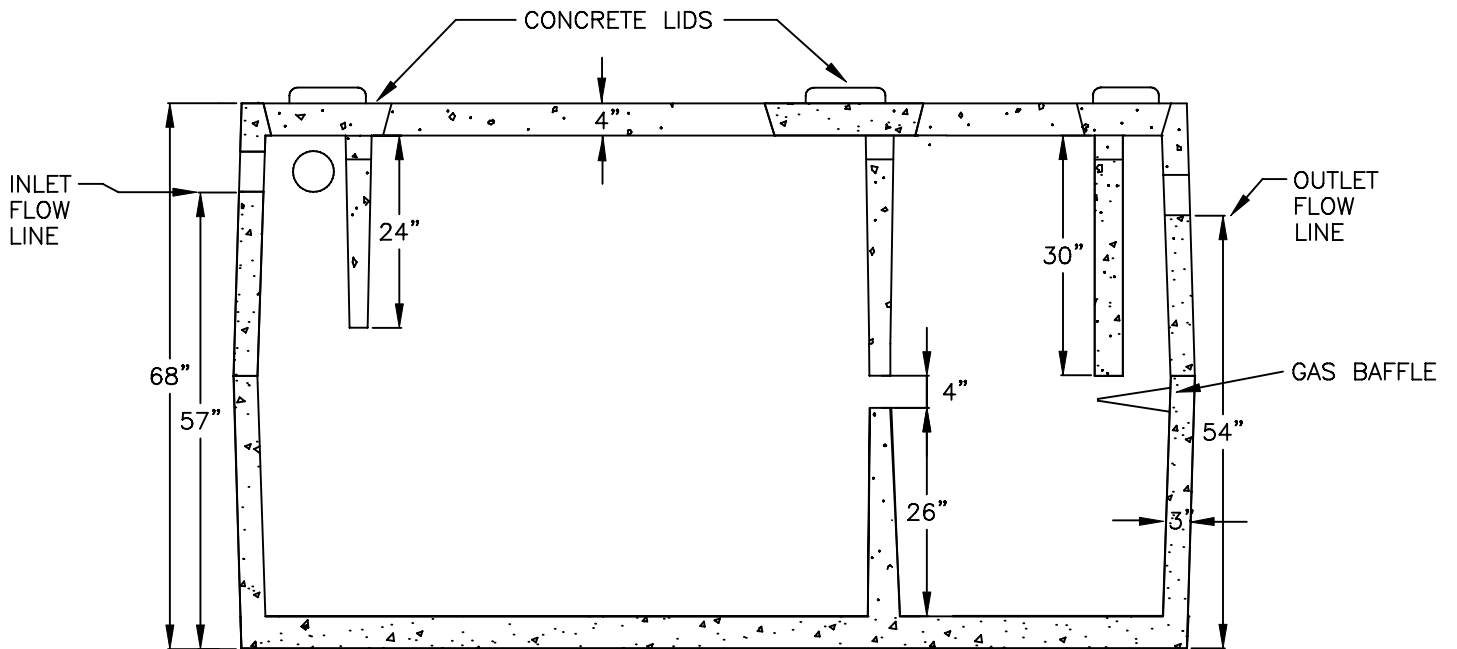

CUT AWAY SIDE VIEW

DARNALL CONCRETE PRODUCTS COMPANY

1500 GALLON SEPTIC TANK DETAIL

6/26/2012